

CS5302

Two-Phase Buck Controller with Integrated Gate Drivers and 4-Bit DAC

The CS5302 is a two-phase step down controller which incorporates all control functions required to power high performance processors and high current power supplies. Proprietary multi-phase architecture guarantees balanced load current distribution and reduces overall solution cost in high current applications. Enhanced V²™ control architecture provides the fastest possible transient response, excellent overall regulation, and ease of use.

The CS5302 multi-phase architecture reduces output voltage and input current ripple, allowing for a significant reduction in inductor values and a corresponding increase in inductor current slew rate. This approach allows a considerable reduction in input and output capacitor requirements, as well as reducing overall solution size and cost.

Features

- Enhanced V² Control Method
- 4-Bit DAC with 1% Accuracy
- Adjustable Output Voltage Positioning
- 4 On-Board Gate Drivers
- 200 kHz to 800 kHz Operation Set by Resistor
- Current Sensed through Buck Inductors, Sense Resistors, or V-S Control
- Hiccup Mode Current Limit
- Individual Current Limits for Each Phase
- On-Board Current Sense Amplifiers
- 3.3 V, 1.0 mA Reference Output
- On/Off Control (through Soft Start Pin)
- Power Good Output with Internal Delay



ON Semiconductor™

<http://onsemi.com>

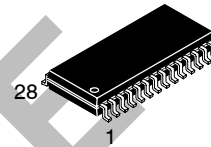

SO-28L
DW SUFFIX
CASE 751F

MARKING DIAGRAM

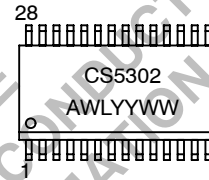

A = Assembly Location
WL, L = Wafer Lot
YY, Y = Year
WW, W = Work Week

PIN CONNECTIONS

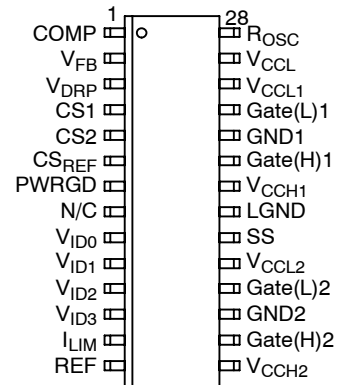

ORDERING INFORMATION

Device	Package	Shipping
CS5302GDW28	SO-28L	27 Units/Rail
CS5302GDWR28	SO-28L	1000 Tape & Reel

CS5302

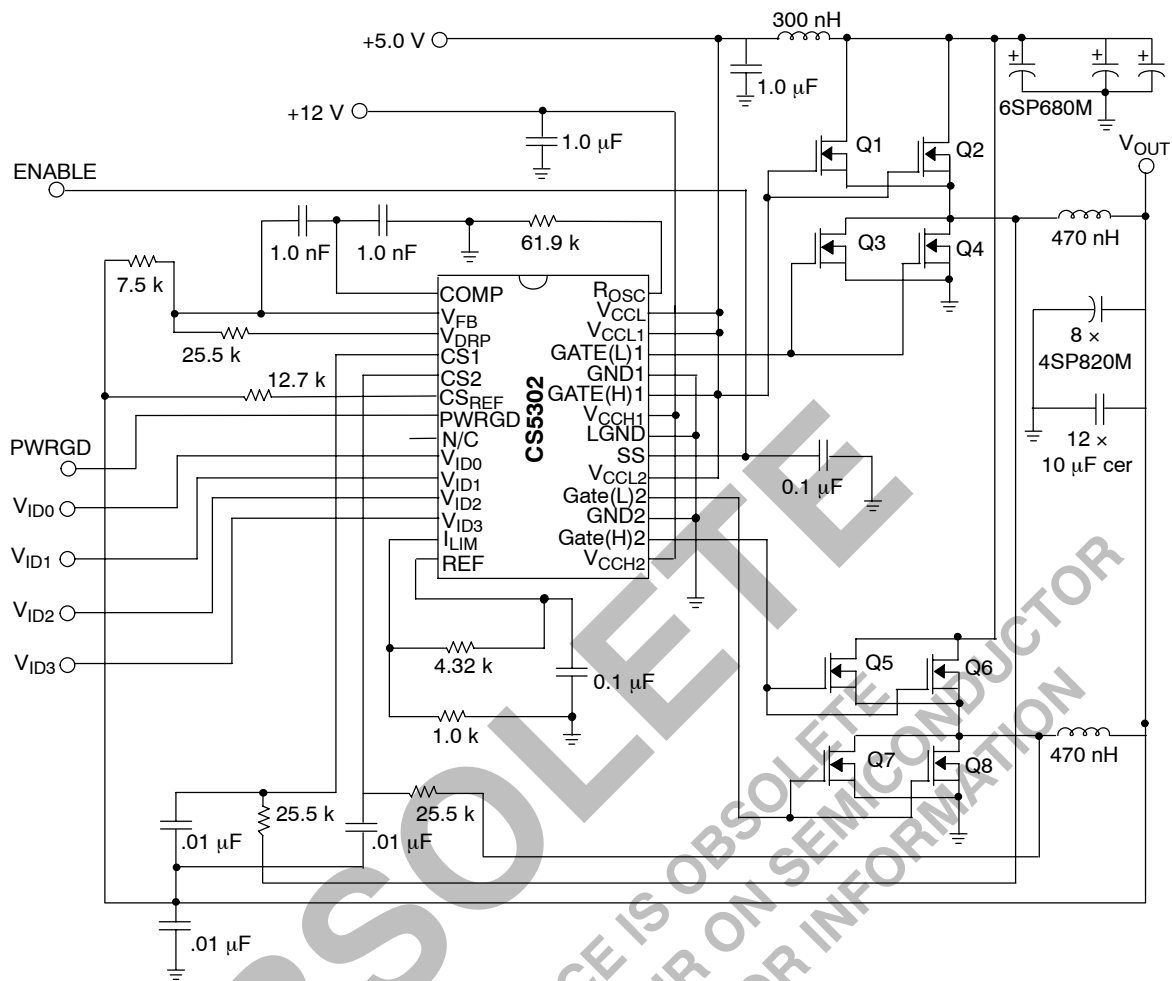

Figure 1. Application Diagram, 5.0 V to 1.6 V, 35 A Converter

ABSOLUTE MAXIMUM RATINGS*

Rating	Value	Unit
Operating Junction Temperature	150	°C
Lead Temperature Soldering:	Reflow: (SMD styles only) (Note 1)	230 peak °C
Storage Temperature Range	-65 to +150	°C
ESD Susceptibility (Human Body Model)	2.0	kV

1. 60 second maximum above 183°C.

*The maximum package power dissipation must be observed.

ABSOLUTE MAXIMUM RATINGS

Pin Name	Pin Symbol	V _{MAX}	V _{MIN}	I _{SOURCE}	I _{SINK}
Power for Logic	V _{CCL}	16 V	-0.3 V	N/A	50 mA
Power for Gate(L)1	V _{CCL1}	16 V	-0.3 V	N/A	1.5 A, 1.0 µs 200 mA DC
Power for Gate(L)2	V _{CCL2}	16 V	-0.3 V	N/A	1.5 A, 1.0 µs 200 mA DC
Power Gate(H)1	V _{CCH1}	20 V	-0.3 V	N/A	1.5 A, 1.0 µs 200 mA DC
Power for Gate(H)2	V _{CCH2}	20 V	-0.3 V	N/A	1.5 A, 1.0 µs 200 mA DC
Power Good Output	PWRGD	6.0 V	-0.3 V	1.0 mA	20 mA

ABSOLUTE MAXIMUM RATINGS (continued)

Pin Name	Pin Symbol	V _{MAX}	V _{MIN}	I _{SOURCE}	I _{SINK}
Soft Start Capacitor	SS	6.0 V	-0.3 V	1.0 mA	1.0 mA
Voltage Feedback Compensation Network	COMP	6.0 V	-0.3 V	1.0 mA	1.0 mA
Voltage Feedback Input	V _{FB}	6.0 V	-0.3 V	1.0 mA	1.0 mA
Output for Adjusting Adaptive Voltage Position	V _{DRP}	6.0 V	-0.3 V	1.0 mA	1.0 mA
Frequency Resistor	R _{OSC}	6.0 V	-0.3 V	1.0 mA	1.0 mA
Reference Output	REF	6.0 V	-0.3 V	1.0 mA	50 mA
High-Side FET Drivers	GATE(H)	20 V	-0.3 V DC -2.0 V for 100 ns	1.5 A, 1.0 μs 200 mA DC	1.5 A, 1.0 μs 200 mA DC
Low Side FET Drivers	GATE(L)	16 V	-0.3 V DC -2.0 V for 100 ns	1.5 A, 1.0 μs 200 mA DC	1.5 A, 1.0 μs 200 mA DC
Return for Logic	LGND	N/A	N/A	50 mA	N/A
Return for #1 Driver	GND1	0.3 V	-0.3 V	2.0 A, 1.0 μs 200 mA DC	N/A
Return for #2 Driver	GND2	0.3 V	-0.3 V	2.0 A, 1.0 μs 200 mA DC	N/A
Current Sense for Phases 1-2	CS1-CS2	6.0 V	-0.3 V	1.0 mA	1.0 mA
Current Limit Set Point	I _{LIM}	6.0 V	-0.3 V	1.0 mA	1.0 mA
Current Sense Reference	CS _{REF}	6.0 V	-0.3 V	1.0 mA	1.0 mA
Voltage ID DAC Inputs	V _{ID0-3}	6.0 V	-0.3 V	1.0 mA	1.0 mA

ELECTRICAL CHARACTERISTICS (0°C < T_A < 70°C; 0°C < T_J < 125°C; 4.7 V < V_{CCL} < 14 V; 10 V < V_{CCH} < 20 V; C_{GATE(H)} = 3.3 nF, C_{GATE(L)} = 3.3 nF, R_{R(OSC)} = 32.4 k, C_{COMP} = 1.0 nF, C_{SS} = 0.1 μF, C_{REF} = 0.1 μF, DAC Code 1001, C_{VCC} = 1.0 μF, I_{LIM} ≈ 1.0 V; unless otherwise specified.)

Characteristic	Test Conditions	Min	Typ	Max	Unit
----------------	-----------------	-----	-----	-----	------

Voltage Identification DAC (0 = Connected to V_{SS}; 1 = Open or Pull-up to 3.3 V)

Accuracy (all codes)				Measure V _{FB} = COMP			±0.0	%
V _{ID3}	V _{ID2}	V _{ID1}	V _{ID0}					
1	1	1	1	-	1.287	1.300	1.313	V
1	1	1	0	-	1.337	1.350	1.364	V
1	1	0	1	-	1.386	1.400	1.414	V
1	1	0	0	-	1.436	1.450	1.465	V
1	0	1	1	-	1.485	1.500	1.515	V
1	0	1	0	-	1.535	1.550	1.566	V
1	0	0	1	-	1.584	1.600	1.616	V
1	0	0	0	-	1.634	1.650	1.667	V
0	1	1	1	-	1.683	1.700	1.717	V
0	1	1	0	-	1.733	1.750	1.768	V
0	1	0	1	-	1.782	1.800	1.818	V
0	1	0	0	Not Allowed	-	-	-	V
0	0	1	1	Not Allowed	-	-	-	-

CS5302

ELECTRICAL CHARACTERISTICS (continued) ($0^{\circ}\text{C} < T_A < 70^{\circ}\text{C}$; $0^{\circ}\text{C} < T_J < 125^{\circ}\text{C}$; $4.7\text{ V} < V_{\text{CCL}} < 14\text{ V}$; $10\text{ V} < V_{\text{CCH}} < 20\text{ V}$; $C_{\text{GATE(H)}} = 3.3\text{ nF}$, $C_{\text{GATE(L)}} = 3.3\text{ nF}$, $R_{\text{R(OSC)}} = 32.4\text{ k}$, $C_{\text{COMP}} = 1.0\text{ nF}$, $C_{\text{SS}} = 0.1\text{ }\mu\text{F}$, $C_{\text{REF}} = 0.1\text{ }\mu\text{F}$, DAC Code 1001, $C_{\text{VCC}} = 1.0\text{ }\mu\text{F}$, $I_{\text{LIM}} \approx 1.0\text{ V}$; unless otherwise specified.)

Characteristic	Test Conditions	Min	Typ	Max	Unit
----------------	-----------------	-----	-----	-----	------

Voltage Identification DAC (0 = Connected to V_{SS} ; 1 = Open or Pull-up to 3.3 V)

0	0	1	0	Not Allowed	-	-	-	-
0	0	0	1	Not Allowed	-	-	-	-
0	0	0	0	Not Allowed	-	-	-	-
Input Threshold	$V_{\text{ID3}}, V_{\text{ID2}}, V_{\text{ID1}}, V_{\text{ID0}}$	1.00	1.25	1.50	V			
Input Pull-up Resistance	$V_{\text{ID3}}, V_{\text{ID2}}, V_{\text{ID1}}, V_{\text{ID0}}$	25	50	100	k Ω			
Pull-up Voltage	-	3.15	3.30	3.45	V			

Power Good Output

Power Good Fault Delay	$C_{\text{SREF}} = V_{\text{DAC}}$ to $V_{\text{DAC}} \pm 5\%$	25	50	125	μs
Output Low Voltage	$C_{\text{SREF}} = 1.0\text{ V}$, $I_{\text{PWRGD}} = 4.0\text{ mA}$	-	0.25	0.40	V
Output Leakage Current	$C_{\text{SREF}} = 1.6\text{ V}$, $I_{\text{PWRGD}} = 5.5\text{ V}$	-	0.1	10	μA
Lower Threshold	% of Nominal VID Code	-14	-11	-8	%
Upper Threshold	% of Nominal VID Code	8	11	14	%

Voltage Feedback Error Amplifier

V_{FB} Bias Current (Note 2)	$1.2\text{ V} < V_{\text{FB}} < 1.9\text{ V}$	9.0	10.3	11.5	μA
COMP Source Current	COMP = 0.5 V to 2.0 V; $V_{\text{FB}} = 1.75\text{ V}$; DAC = 0101	15	30	60	μA
COMP Sink Current	COMP = 0.5 V to 2.0 V; $V_{\text{FB}} = 1.85\text{ V}$; DAC = 0101	15	30	60	μA
COMP Max Voltage	$V_{\text{FB}} = 1.75\text{ V}$ COMP Open; DAC = 0101	2.4	2.7	-	V
COMP Min Voltage	$V_{\text{FB}} = 1.85\text{ V}$ COMP Open; DAC = 0101	-	0.1	0.2	V
Transconductance	$-10\text{ }\mu\text{A} < I_{\text{COMP}} < +10\text{ }\mu\text{A}$	-	32	-	mmho
Output Impedance	-	-	2.5	-	M Ω
Open Loop DC Gain	Note 3	60	90	-	dB
Unity Gain Bandwidth	0.01 μF COMP Capacitor	-	400	-	kHz
PSRR @ 1.0 kHz	-	-	70	-	dB

Soft Start

Soft Start Charge Current	$0.2\text{ V} \leq \text{SS} \leq 3.0\text{ V}$	15	30	50	μA
Soft Start Discharge Current	$0.2\text{ V} \leq \text{SS} \leq 3.0\text{ V}$	4.0	7.5	13	μA
Hiccup Mode Charge/Discharge Ratio	-	3.0	4.0	-	-
Peak Soft Start Charge Voltage	-	3.3	4.0	4.2	V
Soft Start Discharge Threshold Voltage	-	0.20	0.27	0.34	V

- The V_{FB} Bias Current changes with the value of R_{OSC} per Figure 4.
- Guaranteed by design. Not tested in production.

CS5302

ELECTRICAL CHARACTERISTICS (continued) ($0^{\circ}\text{C} < T_A < 70^{\circ}\text{C}$; $0^{\circ}\text{C} < T_J < 125^{\circ}\text{C}$; $4.7\text{ V} < V_{\text{CCL}} < 14\text{ V}$; $10\text{ V} < V_{\text{CCH}} < 20\text{ V}$; $C_{\text{GATE(H)}} = 3.3\text{ nF}$, $C_{\text{GATE(L)}} = 3.3\text{ nF}$, $R_{\text{R(OSC)}} = 32.4\text{ k}$, $C_{\text{COMP}} = 1.0\text{ nF}$, $C_{\text{SS}} = 0.1\text{ }\mu\text{F}$, $C_{\text{REF}} = 0.1\text{ }\mu\text{F}$, DAC Code 1001, $C_{\text{VCC}} = 1.0\text{ }\mu\text{F}$, $I_{\text{LIM}} \approx 1.0\text{ V}$; unless otherwise specified.)

Characteristic	Test Conditions	Min	Typ	Max	Unit
----------------	-----------------	-----	-----	-----	------

PWM Comparators

Minimum Pulse Width	Measured from CSx to GATE(H) $V(V_{\text{FB}}) = V(\text{CS}_{\text{REF}}) = 1.0\text{ V}$, $V(\text{COMP}) = 1.5\text{ V}$ 60 mV step applied between V_{CSx} and V_{CREF}	–	350	515	ns
Channel Start Up Offset	$V(\text{CS1}) = V(\text{CS2}) = V(V_{\text{FB}}) = V(\text{CS}_{\text{REF}}) = 0\text{ V}$; Measure $V(\text{COMP})$ when GATE(H)1, (H)2, switch high	0.3	0.4	0.5	V

Gate(H) and Gate(L)

High Voltage (AC)	Note 4 Measure $V_{\text{CCLX}} - \text{Gate(L)}_X$ or $V_{\text{CCHX}} - \text{Gate(H)}_X$	–	0	1.0	V
Low Voltage (AC)	Note 4 Measure Gate(L)_X or Gate(H)_X	–	0	0.5	V
Rise Time Gate(H)_X	$1.0\text{ V} < \text{GATE} < 8.0\text{ V}$; $V_{\text{CCHX}} = 10\text{ V}$	–	35	80	ns
Rise Time Gate(L)_X	$1.0\text{ V} < \text{GATE} < 8.0\text{ V}$; $V_{\text{CCLX}} = 10\text{ V}$	–	35	80	ns
Fall Time Gate(H)_X	$8.0\text{ V} > \text{GATE} > 1.0\text{ V}$; $V_{\text{CCHX}} = 10\text{ V}$	–	35	80	ns
Fall Time Gate(L)_X	$8.0\text{ V} > \text{GATE} > 1.0\text{ V}$; $V_{\text{CCLX}} = 10\text{ V}$	–	35	80	ns
Gate(H) to Gate(L) Delay	$\text{Gate(H)}_X < 2.0\text{ V}$, $\text{Gate(L)}_X > 2.0\text{ V}$	30	65	110	ns
Gate(L) to Gate(H) Delay	$\text{Gate(L)}_X < 2.0\text{ V}$, $\text{Gate(H)}_X > 2.0\text{ V}$	30	65	110	ns
GATE Pull-down	Force 100 μA into Gate Driver with no power applied to V_{CCHX} and $V_{\text{CCLX}} = 2\text{ V}$.	–	1.2	1.6	V

Oscillator

Switching Frequency	Measure any phase ($R_{\text{OSC}} = 32.4\text{ k}$)	300	400	500	kHz
Switching Frequency	Note 4 Measure any phase ($R_{\text{OSC}} = 63.4\text{ k}$)	150	200	250	kHz
Switching Frequency	Note 4 Measure any phase ($R_{\text{OSC}} = 16.2\text{ k}$)	600	800	1000	kHz
R_{OSC} Voltage		–	1.0	–	V
Phase Delay		165	180	195	deg

Adaptive Voltage Positioning

V_{DRP} Output Voltage to DAC_{OUT} Offset	$\text{CS1} = \text{CS2} = \text{CS}_{\text{REF}}$, $V_{\text{FB}} = \text{COMP}$ Measure $V_{\text{DRP}} - \text{COMP}$	–15	–	15	mV
Maximum V_{DRP} Voltage	$(\text{CS1} = \text{CS2}) - C_{\text{REF}} = 50\text{ mV}$, $V_{\text{FB}} = \text{COMP}$, Measure $V_{\text{DRP}} - \text{COMP}$	240	310	380	mV
Current Sense Amp to V_{DRP} Gain	–	2.4	3.0	3.8	V/V

Current Sensing and Sharing

CS_{REF} Input Bias Current	$V(\text{CSx}) = V(\text{CS}_{\text{REF}}) = 0\text{ V}$	–	0.5	4.0	μA
$\text{CS1}-\text{CS2}$ Input Bias Current	$V(\text{CSx}) = V(\text{CS}_{\text{REF}}) = 0\text{ V}$	–	0.2	2.0	μA
Current Sense Amplifiers Gain	–	2.8	3.15	3.53	V/V
Current Sense Amp Mismatch	Note 4 $0 \leq (\text{CSx} - \text{CS}_{\text{REF}}) \leq 50\text{ mV}$	–5.0	–	5.0	mV
Current Sense Amplifiers Input Common Mode Range Limit	Note 4	0	–	$V_{\text{CCL}} - 2$	V
Current Sense Input to I_{LIM} Gain	$0.25\text{ V} < I_{\text{LIM}} < 1.20\text{ V}$	5.0	6.25	8.0	V/V
Current Limit Filter Slew Rate	Note 4	4.0	10	26	mV/ μs

4. Guaranteed by design. Not tested in production.

CS5302

ELECTRICAL CHARACTERISTICS (continued) ($0^{\circ}\text{C} < T_A < 70^{\circ}\text{C}$; $0^{\circ}\text{C} < T_J < 125^{\circ}\text{C}$; $4.7\text{ V} < V_{\text{CCL}} < 14\text{ V}$; $10\text{ V} < V_{\text{CCH}} < 20\text{ V}$; $C_{\text{GATE(H)}} = 3.3\text{ nF}$, $C_{\text{GATE(L)}} = 3.3\text{ nF}$, $R_{\text{R(OSC)}} = 32.4\text{ k}$, $C_{\text{COMP}} = 1.0\text{ nF}$, $C_{\text{SS}} = 0.1\text{ }\mu\text{F}$, $C_{\text{REF}} = 0.1\text{ }\mu\text{F}$, DAC Code 1001, $C_{\text{VCC}} = 1.0\text{ }\mu\text{F}$, $I_{\text{LIM}} \approx 1.0\text{ V}$; unless otherwise specified.)

Characteristic	Test Conditions	Min	Typ	Max	Unit
Current Sensing and Sharing					
I_{LIM} Bias Current	$0 < I_{\text{LIM}} < 1.0\text{ V}$	–	0.1	1.0	μA
Single Phase Pulse by Pulse Current Limit: $V(\text{CSx}) - V(\text{CS}_{\text{REF}})$	–	90	105	135	mV
Current Share Amplifier Bandwidth	Note 5	1.0	–	–	MHz

Reference Output

V_{REF} Output Voltage	$0\text{ mA} < I(V_{\text{REF}}) < 1.0\text{ mA}$	3.2	3.3	3.4	V
---------------------------------	---	-----	-----	-----	---

General Electrical Specifications

V_{CCL} Operating Current	$V_{\text{FB}} = \text{COMP}$ (no switching)	–	20	24.5	mA
V_{CCL1} Operating Current	$V_{\text{FB}} = \text{COMP}$ (no switching)	–	4.0	5.5	mA
V_{CCL2} Operating Current	$V_{\text{FB}} = \text{COMP}$ (no switching)	–	4.0	5.5	mA
V_{CCH1} Operating Current	$V_{\text{FB}} = \text{COMP}$ (no switching)	–	2.8	4.0	mA
V_{CCH2} Operating Current	$V_{\text{FB}} = \text{COMP}$ (no switching)	–	2.5	3.5	mA
V_{CCL} Start Threshold	GATEs switching, Soft Start charging	4.05	4.4	4.7	V
V_{CCL} Stop Threshold	GATEs stop switching, Soft Start discharging	3.75	4.2	4.6	V
V_{CCL} Hysteresis	GATEs not switching, Soft Start not charging	100	200	300	mV
V_{CCH1} Start Threshold	GATEs switching, Soft Start charging	8.4	9.2	9.9	V
V_{CCH1} Stop Threshold	GATEs stop switching, Soft Start discharging	7.8	8.7	9.6	V
V_{CCH1} Hysteresis	GATEs not switching, Soft Start not charging	300	500	700	mV

5. Guaranteed by design. Not tested in production.

PACKAGE PIN DESCRIPTION

PACKAGE PIN #	PIN SYMBOL	FUNCTION
28 Lead SO Wide		
1	COMP	Output of the error amplifier and input for the PWM comparators.
2	V_{FB}	Voltage Feedback Pin. To use Adaptive Voltage Positioning (AVP) select an offset voltage at light load and connect a resistor between V_{FB} and V_{OUT} . The input bias current of the V_{FB} pin and the resistor value determine output voltage offset for zero output current. Short V_{FB} to V_{OUT} for no AVP.
3	V_{DRP}	Current sense output for AVP. The offset of this pin above the DAC voltage is proportional to the output current. Connect a resistor from this pin to V_{FB} to set amount AVP or leave this pin open for no AVP.
4–5	CS1–CS2	Current sense inputs. Connect current sense network for the corresponding phase to each input.
6	CS_{REF}	Reference for current sense amplifiers and input for Power Good comparators. To balance input offset voltages between the inverting and non-inverting inputs of the current sense amplifiers, connect a resistor between CS_{REF} and the output voltage. The value should be 2/5 of the value of the resistors connected to the CSx pins.
7	PWRGD	Power Good Output. Open collector output goes low when CS_{REF} is out of regulation.

CS5302

PACKAGE PIN DESCRIPTION (continued)

PACKAGE PIN #	PIN SYMBOL	FUNCTION
8	N/C	No connection.
9–12	$V_{ID3}-V_{ID0}$	Voltage ID DAC inputs. These pins are internally pulled up to 3.3 V if left open.
13	I_{LIM}	Sets threshold for current limit. Connect to reference through a resistive divider.
14	REF	Reference output. Decouple with 0.1 μ F to LGND.
15	V_{CCH2}	Power for GATE(H)2.
16	Gate(H)2	High side driver #2.
17	GND2	Return for #2 driver.
18	Gate(L)2	Low side driver #2.
19	V_{CCL2}	Power for GATE(L)2.
20	SS	Soft Start capacitor pin. The Soft Start capacitor controls both Soft Start time and hiccup mode frequency. The COMP pin is clamped below Soft Start during Start-Up and hiccup mode.
21	LGND	Return for internal control circuits and IC substrate connection.
22	V_{CCH1}	Power for GATE(H)1. UVLO Sense for High Side Driver supply connects to this pin.
23	Gate(H)1	High side driver #1.
24	GND1	Return #1 drivers.
25	Gate(L)1	Low side driver #1.
26	V_{CCL1}	Power for GATE(L)1.
27	V_{CCL}	Power for internal control circuits. UVLO Sense for Logic connects to this pin.
28	R_{OSC}	A resistor from this pin to ground sets operating frequency and V_{FB} bias current.

CS5302

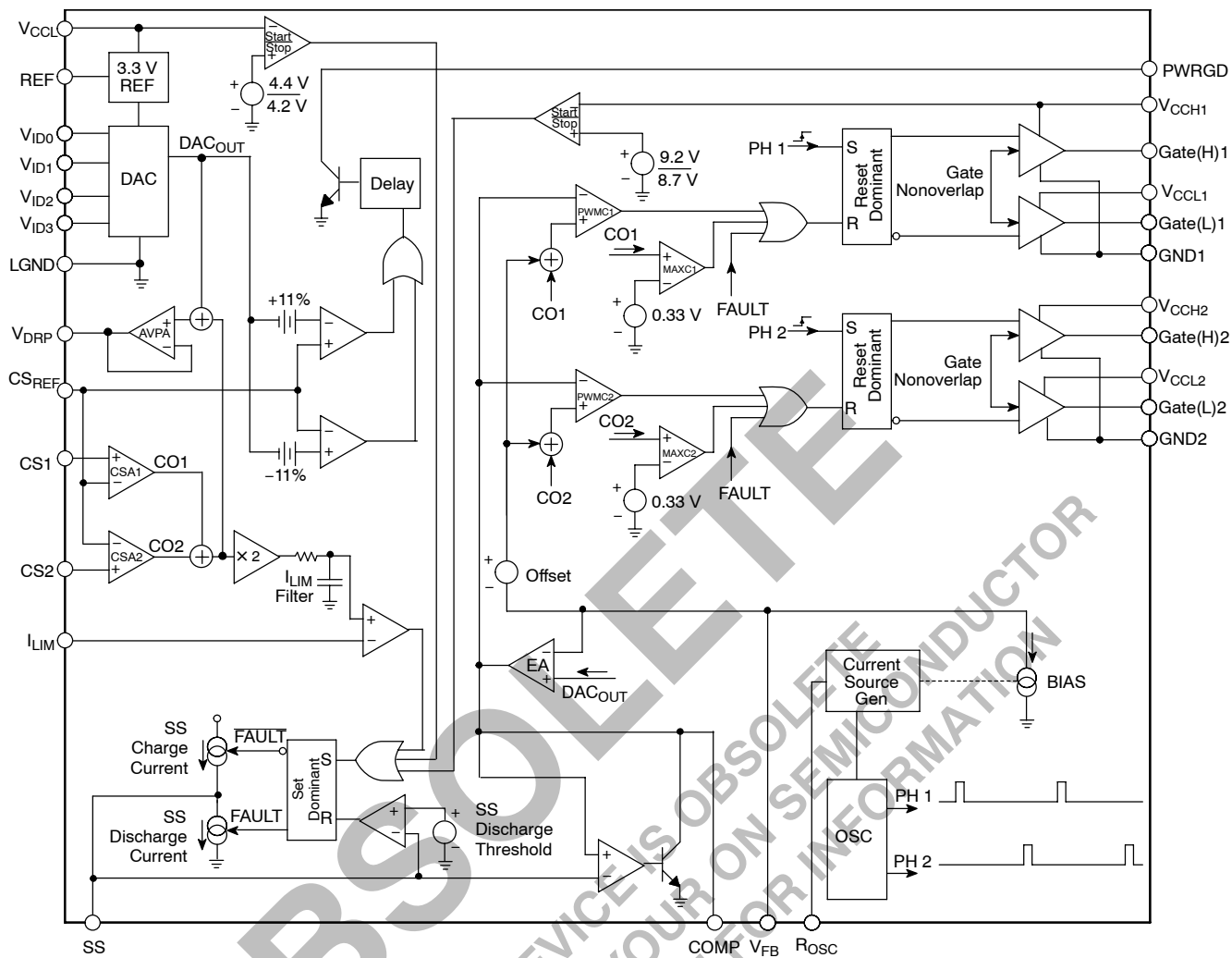

Figure 2. Block Diagram

TYPICAL PERFORMANCE CHARACTERISTICS

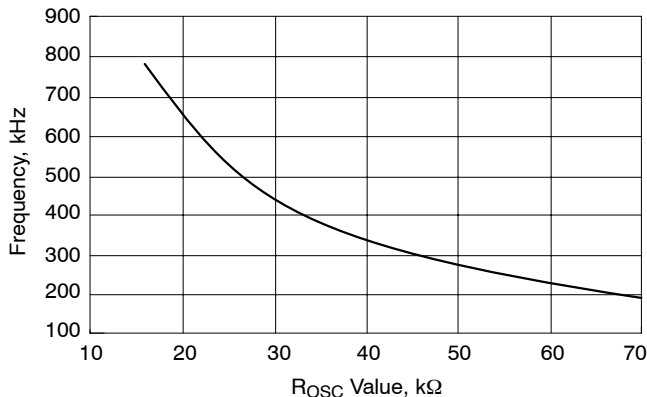

Figure 3. Oscillator Frequency

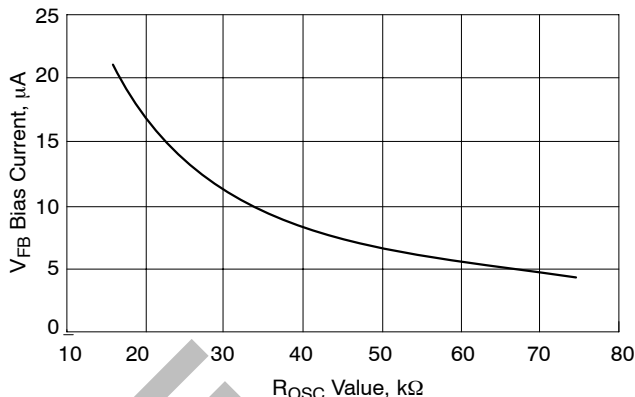

Figure 4. V_{FB} Bias Current vs. R_{OSC} Value

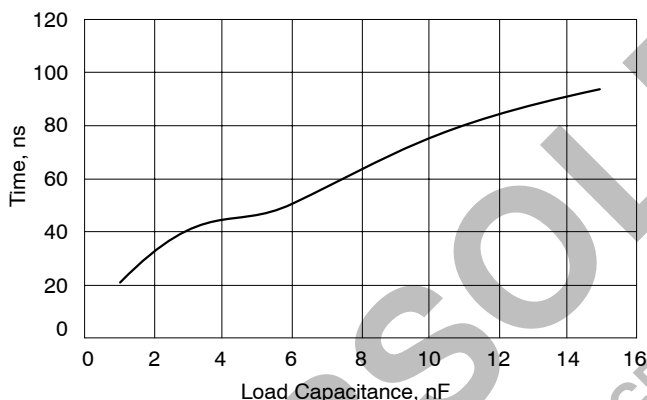

Figure 5. Gate(H) Rise-time vs. Load Capacitance measured from 1.0 V to 4.0 V with V_{CC} at 5.0 V.

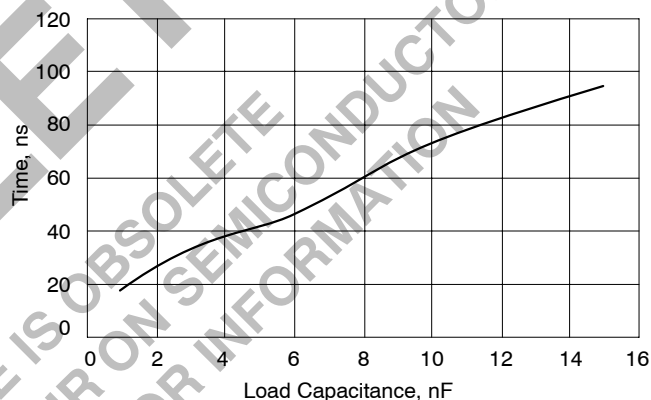

Figure 6. Gate(H) Fall-time vs. Load Capacitance measured from 4.0 V to 1.0 V with V_{CC} at 5.0 V.

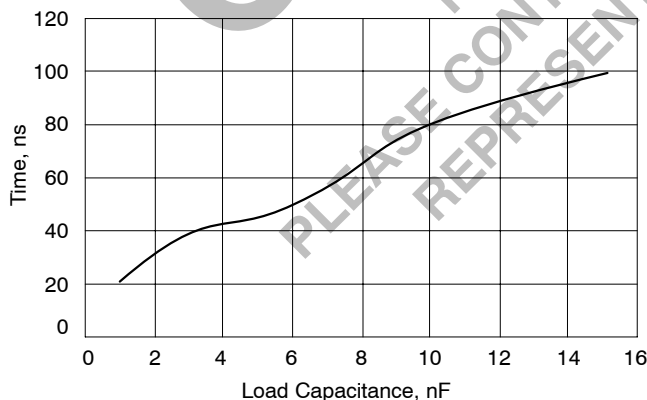

Figure 7. Gate(L) Rise-time vs. Load Capacitance measured from 4.0 V to 1.0 V with V_{CC} at 5.0 V.

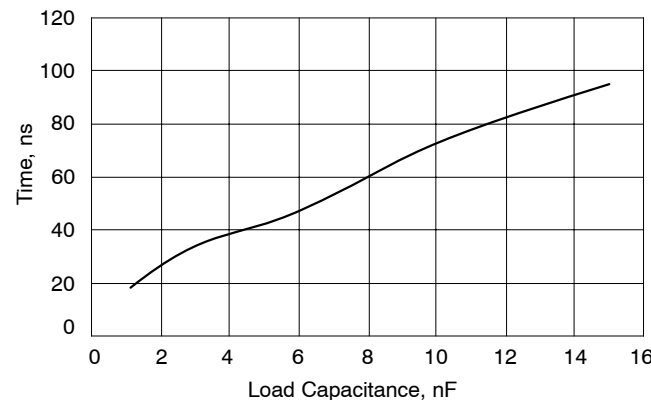

Figure 8. Gate(L) Fall-time vs. Load Capacitance measured from 4.0 V to 1.0 V with V_{CC} at 5.0 V.

APPLICATIONS INFORMATION

FIXED FREQUENCY MULTI-PHASE CONTROL

In a multi-phase converter, multiple converters are connected in parallel and are switched on at different times. This reduces output current from the individual converters and increases the apparent ripple frequency. Because several converters are connected in parallel, output current can ramp up or down faster than a single converter (with the same value output inductor) and heat is spread among multiple components.

The CS5302 uses a two-phase, fixed frequency, Enhanced V^2 architecture. Each phase is delayed 180° from the previous phase. Normally GATE(H) transitions high at the beginning of each oscillator cycle. Inductor current ramps up until the combination of the current sense signal and the output ripple trip the PWM comparator and bring GATE(H) low. Once GATE(H) goes low, it will remain low until the beginning of the next oscillator cycle. While GATE(H) is high, the enhanced V^2 loop will respond to line and load transients. Once GATE(H) is low, the loop will not respond again until the beginning of the next cycle. Therefore, constant frequency Enhanced V^2 will typically respond within the off-time of the converter.

The Enhanced V^2 architecture measures and adjusts current in each phase. An additional input (Cx) for inductor current information has been added to the V^2 loop for each phase as shown in Figure 9.

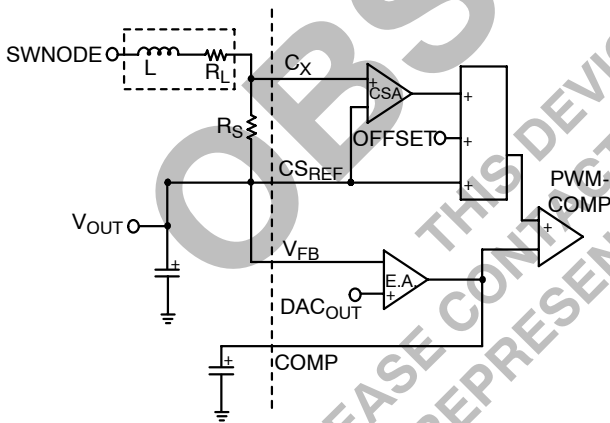

Figure 9. Enhanced V^2 Feedback and Current Sense Scheme

The inductor current is measured across R_S , amplified by CSA and summed with the OFFSET and Output Voltage at the non-inverting input of the PWM comparator. The inductor current provides the PWM ramp and as inductor current increases the voltage on the positive pin of the PWM comparator rises and terminates the PWM cycle. If the

inductor starts the cycle with a higher current, the PWM cycle will terminate earlier providing negative feedback. The CS5302 provides a Cx input for each phase, but the CS_{REF} , V_{FB} and COMP inputs are common to all phases. Current sharing is accomplished by referencing all phases to the same V_{FB} and COMP pins, so that a phase with a larger current signal will turn off earlier than phases with a smaller current signal.

Including both current and voltage information in the feedback signal allows the open loop output impedance of the power stage to be controlled. When the average output current is zero, the COMP pin will be only 1/2 of the steady state ramp height plus the OFFSET above the output voltage. If the COMP pin is held steady and the inductor current changes, there must also be a change in the output voltage. Or, in a closed loop configuration when the output current changes, the COMP pin must move to keep the same output voltage. The required change in the output voltage or COMP pin depends on the scaling of the current feedback signal and is calculated as

$$\Delta V = R_S \times CSA \text{ Gain} \times \Delta I$$

The single-phase power stage output impedance is:

$$\text{Single Stage Impedance} = \Delta V / \Delta I = R_S \times CSA \text{ Gain.}$$

The multi-phase power stage output impedance is the single-phase output impedance divided by the number of phases. The output impedance of the power stage determines how the converter will respond during the first few μs of a transient before the feedback loop has repositioned the COMP pin.

The peak output current of each phase can also be calculated from;

$$I_{pkout} \text{ (per phase)} = \frac{V_{COMP} - V_{FB} - V_{OFFSET}}{R_S \times CSA \text{ Gain}}$$

Figure 10 shows the step response of a single phase with the COMP pin at a fixed level. Before T1 the converter is in normal steady state operation. The inductor current provides the PWM ramp through the Current Sense Amplifier. The PWM cycle ends when the sum of the current signal, voltage signal and OFFSET exceed the level of the COMP pin. At T1 the output current increases and the output voltage sags. The next PWM cycle begins and the cycle continues longer than previously while the current signal increases enough to make up for the lower voltage at the V_{FB} pin and the cycle ends at T2. After T2 the output voltage remains lower than at light load and the current signal level is raised so that the sum of the current and voltage signal is the same as with the original load. In a closed loop system the COMP pin would

move higher to restore the output voltage to the original level.

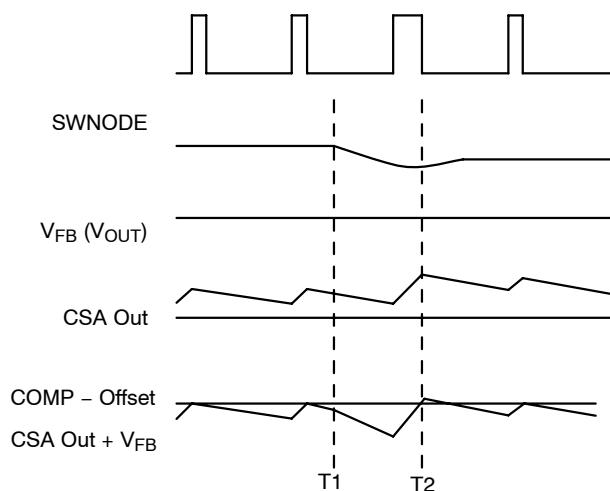

Figure 10. Open Loop Operation

Inductive Current Sensing

For lossless sensing, current can be sensed across the inductor as shown in Figure 11. In the diagram L is the output inductance and R_L is the inherent inductor resistance. To compensate the current sense signal the values of R1 and C1 are chosen so that $L/R_L = R1 \times C1$. If this criteria is met the current sense signal will be the same shape as the inductor current, the voltage signal at C_x will represent the instantaneous value of inductor current and the circuit can be analyzed as if a sense resistor of value R_L was used as a sense resistor (R_S).

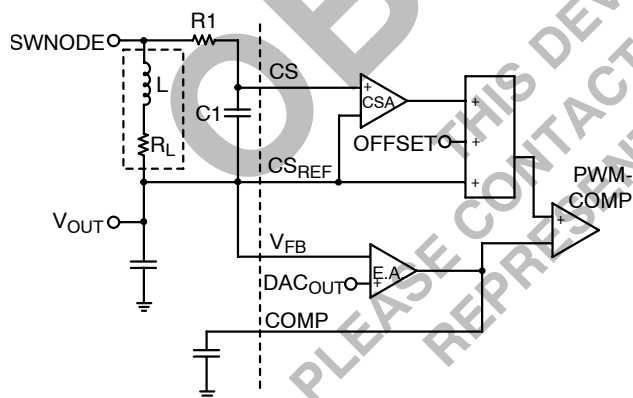

Figure 11. Lossless Inductive Current Sensing with Enhanced V^2

When choosing or designing inductors for use with inductive sensing tolerances and temperature, effects should be considered. Cores with a low permeability material or a large gap will usually have minimal inductance change with temperature and load. Copper magnet wire has a temperature coefficient of 0.39% per °C. The increase in

winding resistance at higher temperatures should be considered when setting the I_{LIM} threshold. If a more accurate current sense is required than inductive sensing can provide, current can be sensed through a resistor as shown in Figure 9.

Current Sharing Accuracy

PCB traces that carry inductor current can be used as part of the current sense resistance depending on where the current sense signal is picked off. For accurate current sharing, the current sense inputs should sense the current at the same point for each phase and the connection to the CS_{REF} should be made so that no phase is favored. (In some cases, especially with inductive sensing, resistance of the pcb can be useful for increasing the current sense resistance.) The total current sense resistance used for calculations must include any pcb trace between the CS inputs and the CS_{REF} input that carries inductor current.

Current Sense Amplifier Input Mismatch and the value of the current sense element will determine the accuracy of current sharing between phases. The worst case Current Sense Amplifier Input Mismatch is 5.0 mV and will typically be within 3.0 mV. The difference in peak currents between phases will be the CSA Input Mismatch divided by the current sense resistance. If all current sense elements are of equal resistance a 3.0 mV mismatch with a 2.0 mΩ sense resistance will produce a 1.5 A difference in current between phases.

Operation at > 50% Duty Cycle

For operation at duty cycles above 50% Enhanced V^2 will exhibit subharmonic oscillation unless a compensation ramp is added to each phase. A circuit like the one on the left side of Figure 12 can be added to each current sense network to implement slope compensation. The value of R1 can be varied to adjust the ramp size.

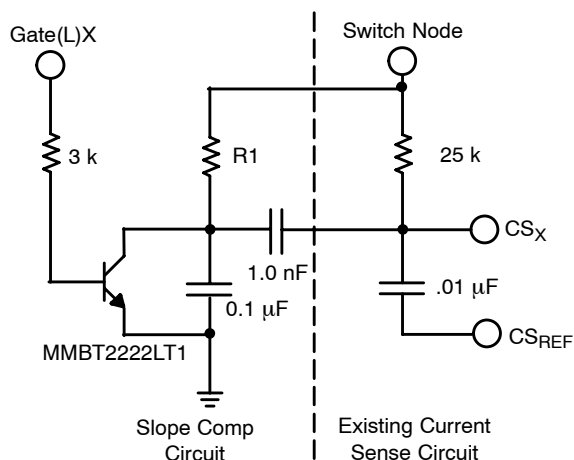

Figure 12. External Slope Compensation Circuit

Ramp Size and Current Sensing

Because the current ramp is used for both the PWM ramp and to sense current, the inductor and sense resistor values will be constrained. A small ramp will provide a quick transient response by minimizing the difference over which the COMP pin must travel between light and heavy loads, but a steady state ramp of 25 mVp-p or greater is typically required to prevent pulse skipping and minimize pulse width jitter. For resistive current sensing, the combination of the inductor and sense resistor values must be chosen to provide a large enough steady state ramp. For large inductor values the sense resistor value must also be increased.

For inductive current sensing, the RC network must meet the requirement of $L/R_L = R \times C$ to accurately sense the AC and DC components of the current the signal. Again the values for L and R_L will be constrained in order to provide a large enough steady state ramp with a compensated current sense signal. A smaller L, or a larger R_L than optimum might be required. But unlike resistive sensing, with inductive sensing, small adjustments can be made easily with the values of R and C to increase the ramp size if needed.

If RC is chosen to be smaller (faster) than L/R_L , the AC portion of the current sensing signal will be scaled larger than the DC portion. This will provide a larger steady state ramp, but circuit performance will be affected and must be evaluated carefully. The current signal will overshoot during transients and settle at the rate determined by $R \times C$. It will eventually settle to the correct DC level, but the error will decay with the time constant of $R \times C$. If this error is excessive it will effect transient response, adaptive positioning and current limit. During transients the COMP pin will be required to overshoot along with the current signal in order to maintain the output voltage. The V_{DRP} pin will also overshoot during transients and possibly slow the response. Single phase overcurrent will trip earlier than it would if compensated correctly and hiccup mode current limit will have a lower threshold for fast rise step loads than for slowly rising output currents.

The waveforms in Figure 13 show a simulation of the current sense signal and the actual inductor current during a positive step in load current with values of $L = 500$ nH, $R_L = 1.6$ m Ω , $R1 = 20$ k and $C1 = .01$ μ F. For ideal current signal compensation the value of R1 should be 31 k Ω . Due to the faster than ideal RC time constant there is an overshoot of 50% and the overshoot decays with a 200 μ s time constant. With this compensation the I_{LIM} pin threshold must be set more than 50% above the full load current to avoid triggering hiccup mode during a large output load step.

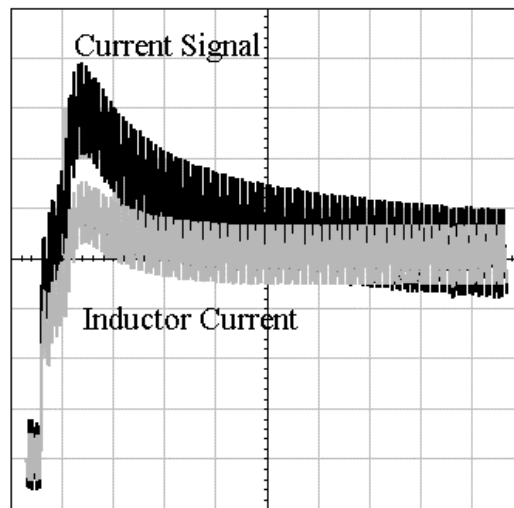

Figure 13. Inductive Sensing waveform during a Step with Fast RC Time Constant (50 μ s/div)

Current Limit

Two levels of overcurrent protection are provided. Any time the voltage on a Current Sense pin exceeds CS_{REF} by more than the Single Phase Pulse by Pulse Current Limit, the PWM comparator for that phase is turned off. This provides fast peak current protection for individual phases. The outputs of all the currents are also summed and filtered to compare an averaged current signal to the voltage on the I_{LIM} pin. If this voltage is exceeded, the fault latch trips and the Soft Start capacitor is discharged by a 7.5 μ A source until the COMP pin reaches 0.2 V. Then Soft Start begins. The converter will continue to operate in this mode until the fault condition is corrected.

Overvoltage Protection

Overvoltage protection (OVP) is provided as a result of the normal operation of the Enhanced V^2 control topology with synchronous rectifiers. The control loop responds to an overvoltage condition within 400 ns, causing the top MOSFET's to shut off and the synchronous MOSFET's to turn on. This results in a "crowbar" action to clamp the output voltage and prevent damage to the load. The regulator will remain in this state until the overvoltage condition ceases or the input voltage is pulled low.

Transient Response and Adaptive Positioning

For applications with fast transient currents the output filter is frequently sized larger than ripple currents require in

order to reduce voltage excursions during transients. Adaptive voltage positioning can reduce peak–peak output voltage deviations during load transients and allow for a smaller output filter. The output voltage can be set higher than nominal at light loads to reduce output voltage sag when the load current is stepped up and set lower than nominal during heavy loads to reduce overshoot when the load current is stepped up. For low current applications a droop resistor can provide fast accurate adaptive positioning. However, at high currents the loss in a droop resistor becomes excessive. For example; in a 50 A converter a 1.0 mΩ resistor to provide a 50 mV change in output voltage between no load and full load would dissipate 2.5 Watts.

Lossless adaptive positioning is an alternative to using a droop resistor, but must respond quickly to changes in load current. Figure 14 shows how adaptive positioning works. The waveform labeled normal shows a converter without adaptive positioning. On the left, the output voltage sags when the output current is stepped up and later overshoots when current is stepped back down. With fast (ideal) adaptive positioning the peak to peak excursions are cut in half. In the slow adaptive positioning waveform the output voltage is not repositioned quickly enough after current is stepped up and the upper limit is exceeded.

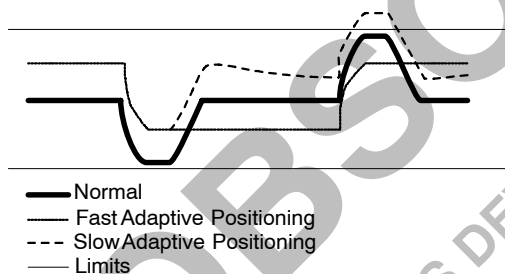

Figure 14. Adaptive Positioning

The CS5302 can be configured to adjust the output voltage based on the output current of the converter. (Refer to the application diagram on page 2.)

To set the no-load positioning, a resistor is placed between the output voltage and V_{FB} pin. The V_{FB} bias current will develop a voltage across the resistor to increase the output voltage. The V_{FB} bias current is dependent on the value of R_{OSC} . See Figure 4.

During no load conditions the V_{DRP} pin is at the same voltage as the V_{FB} pin, so none of the V_{FB} bias current flows through the V_{DRP} resistor. When output current increases the V_{DRP} pin increases proportionally and the V_{DRP} pin current offsets the V_{FB} bias current and causes the output voltage to decrease.

The V_{FB} and V_{DRP} pins take care of the slower and DC voltage positioning. The first few μs are controlled primarily by the ESR and ESL of the output filter. The transition between fast and slow positioning is controlled by the ramp size and the error amp compensation. If the ramp size is too large or the error amp too slow there will be a long transition

to the final voltage after a transient. This will be most apparent with lower capacitance output filters.

Note: Large levels of adaptive positioning can cause pulse width jitter.

Error Amp Compensation

The transconductance error amplifier requires a capacitor between the COMP pin and GND. Use of values less than 1nF may result in error amp oscillation of several MHz.

The capacitor between the COMP pin and the inverting error amplifier input and the parallel resistance of the V_{FB} resistor and the V_{DRP} resistor are used to roll off the error amp gain. The gain is rolled off at a high enough frequency to give a quick transient response, but low enough to cross zero dB well below the switching frequency to minimize ripple and noise on the COMP pin.

UVLO

The CS5302 has undervoltage lockout functions connected to two pins. One, intended for the logic and low-side drivers, with a 4.4 V turn-on threshold is connected to the V_{CCL} pin. A second, intended for the high side drivers, powered from 12 V has a 9.0 V threshold is connected to the V_{CCH1} pin.

Both thresholds must be exceeded for the converter to start.

Soft Start and Hiccup Mode

A capacitor between the Soft Start pin and GND controls Soft Start and hiccup mode slopes. A 0.1 μF capacitor with the 30 μA charge current will allow the output to ramp up at 0.3 V/ms or 1.5 V in 5.0 ms at start-up.

When a fault is detected due to overcurrent or UVLO the converter will enter a low duty cycle hiccup mode. During hiccup mode the converter will not switch from the time a fault is detected until the Soft Start capacitor has discharged below the Soft Start Discharge Threshold and then charged back up above the Channel Start Up Offset.

The Soft Start pin will disable the converter when pulled below 0.3 V.

Layout Guidelines

With the fast rise, high output currents of microprocessor applications, parasitic inductance and resistance should be considered when laying out the power, filter and feedback signal sections of the board. Typically, a multi-layer board with at least one ground plane is recommended. If the layout is such that high currents can exist in the ground plane underneath the controller or control circuitry, the ground plane can be slotted to reroute the currents away from the controller. The slots should typically not be placed between the controller and the output voltage or in the return path of the gate drive. Additional power and ground planes or islands can be added as required for a particular layout.

Gate drives experience high di/dt during switching and the inductance of gate drive traces should be minimized. Gate

drive traces should be kept as short and wide as practical and should have a return path directly below the gate trace.

Output filter components should be placed on wide planes connected directly to the load to minimize resistive drops during heavy loads and inductive drops and ringing during transients. If required, the planes for the output voltage and return can be interleaved to minimize inductance between the filter and load.

Voltage feedback should be taken from a point of the output or the output filter that doesn't favor any one phase. If the feedback connection is closer to one inductor than the others the ripple associated with that phase may appear larger than the ripple associated with the other phases and poor current sharing can result.

The current sense signal is typically tens of milli-volts. Noise pick-up should be avoided wherever possible. Current feedback traces should be routed away from noisy areas such as switch nodes and gate drive signals. The paths should be matched as well as possible. It is especially important that all current sense signals be picked off at similar points for accurate current sharing. If the current signal is taken from a place other than directly at the inductor any additional resistance between the pick-off point and the inductor appears as part of the inherent inductor resistance and should be considered in design calculations. Capacitors for the current feedback networks should be placed as close to the current sense pins as practical.

DESIGN PROCEDURE

Current Sensing, Power Stage and Output Filter Components

1. Choose the output filter components to meet peak transient requirements. The formula below can be used to provide an approximate starting point for capacitor choice, but will be inadequate to calculate actual values.

$$\Delta V_{PEAK} = (\Delta I / \Delta T) \times ESL + \Delta I \times ESR$$

Ideally the output filter should be simulated with models including ESR, ESL, circuit board parasitics and delays due to switching frequency and converter response. Typically both bulk capacitance (electrolytic, Oscon, etc.) and low impedance capacitance (ceramic chip) will be required. The bulk capacitance provides "hold up" during the converter response. The low impedance capacitance reduces steady state ripple and bypasses the bulk capacitance during slewing of output current.

2. For inductive current sensing (only) choose the current sense network RC to provide a 25 mV minimum ramp during steady state operation.

$$R = (V_{IN} - V_{OUT}) \times \frac{V_{OUT}/V_{IN}}{F \times C \times 25 \text{ mV}}$$

Then choose the inductor value and inherent resistance to satisfy $L/R_L = R \times C$.

For ideal current sense compensation the ratio of L and R_L is fixed, so the values of L and R_L will be a compromise typically with the maximum value R_L limited by conduction losses or inductor temperature rise and the minimum value of L limited by ripple current.

3. For resistive current sensing choose L and R_S to provide a steady state ramp greater than 25 mV.

$$L/R_S = (V_{IN} - V_{OUT}) \times T_{ON}/25 \text{ mV}$$

Again the ratio of L and R_L is fixed and the values of L and R_S will be a compromise.

4. Calculate the high frequency output impedance (ConverterZ) of the converter during transients. This is the impedance of the Output filter ESR in parallel with the power stage output impedance (PwrstgZ) and will indicate how far from the original level (ΔV_R) the output voltage will typically recover to within one switching cycle. For a good transient response ΔV_R should be less than the peak output voltage overshoot or undershoot.

$$\Delta V_R = \text{ConverterZ} \times ESR$$

$$\text{ConverterZ} = \frac{\text{PwrstgZ} \times ESR}{\text{PwrstgZ} + ESR}$$

where:

$$\text{PwrstgZ} = R_S \times \text{CSA Gain}/3.0$$

Multiply the converterZ by the output current step size to calculate where the output voltage should recover to within the first switching cycle after a transient. If the ConverterZ is higher than the value required to recover to where the adaptive positioning is set the remainder of the recovery will be controlled by the error amp compensation and will typically recover in 10–20 μs .

$$\Delta V_R = \Delta I_{OUT} \times \text{ConverterZ}$$

Make sure that ΔV_R is less than the expected peak transient for a good transient response.

5. Adjust L and R_L or R_S as required to meet the best combination of transient response, steady state output voltage ripple and pulse width jitter.

Current Limit

When the sum of the Current Sense amplifiers (V_{ITOTAL}) exceeds the voltage on the I_{LIM} pin the part will enter hiccup mode. For inductive sensing the I_{LIM} pin voltage should be set based on the inductor resistance (or current sense resistor) at max temperature and max current. To set the level of the I_{LIM} pin:

6. $V_{I(LIM)} = R \times I_{OUT(LIM)} \times \text{CS to } I_{LIM} \text{ Gain}$

where:

R is R_L or R_S ;

$I_{OUT(LIM)}$ is the current limit threshold.

For the overcurrent to work properly the inductor time constant (L/R) should be \leq the Current sense RC. If the RC is too fast, during step loads the current waveform will appear larger than it is (typically for a few hundred μs) and may trip the current limit at a level lower than the DC limit.

Adaptive Positioning

- To set the amount of voltage positioning below the DAC setting at no load connect a resistor ($R_{V(FB)}$) between the output voltage and the V_{FB} pin. Choose $R_{V(FB)}$ as;

$$R_{V(FB)} = \text{NL Position} / V_{FB} \text{ Bias Current}$$

See Figure 4 for V_{FB} Bias Current.

- To set the difference in output voltage between no load and full load, connect a resistor ($R_{V(DRP)}$) between the V_{DRP} and V_{FB} pins. $R_{V(DRP)}$ can be calculated in two steps. First calculate the difference between the V_{DRP} and V_{FB} pin at full load. (The V_{FB} voltage should be the same as the DAC voltage during closed loop operation.) Then choose the $R_{V(DRP)}$ to source enough current across $R_{V(FB)}$ for the desired change in output voltage.

$$\Delta V_{V(DRP)} = I_{OUTFL} \times R \times \text{CS to } V_{DRP} \text{ Gain}$$

where:

$R = R_L$ or R_S for one phase;

I_{OUTFL} is the full load output current.

$$R_{V(DRP)} = \Delta V_{DRP} \times R_{V(FB)} / \Delta V_{OUT}$$

Calculate Input Filter Capacitor Current Ripple

The procedure below assumes that phases do not overlap and output inductor ripple current (P-P) is less than the average output current of one phase.

- Calculate Input Current

$$I_{IN} = \frac{V_{OUT} \times I_{OUT}}{(\text{Efficiency} \times V_{IN})}$$

- Calculate Duty Cycle (per phase).

$$\text{Duty Cycle} = \frac{V_{OUT}}{(\text{Efficiency} \times V_{IN})}$$

- Calculate Apparent Duty Cycle.

$$\text{Apparent Duty Cycle} = \text{Duty Cycle} \times \# \text{ of Phases}$$

- Calculate Input Filter Capacitor Ripple Current. Use the chart in Figure 15 to calculate the normalized ripple current (K_{RMS}) based on the reciprocal of Apparent Duty Cycle. Then multiply the input current by K_{RMS} to obtain the Input Filter Capacitor Ripple Current.

$$\text{Ripple (RMS)} = I_{IN} \times K_{RMS}$$

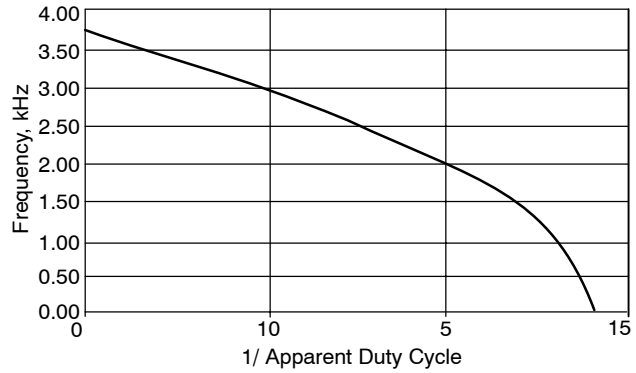

Figure 15. Normalized Input Filter Capacitor Ripple Current

DESIGN EXAMPLE

Choose the component values for a 5.0 V to 1.6 V, 35 A converter with lossless current sensing, adaptive positioning and a 45 A current limit. The adaptive positioning is chosen 30 mV above the nominal V_{OUT} at no load and 40 mV below the no-load position with 35 A out. The peak output voltage transient is 70 mV max during a 32 A step current.

Current Sensing, Power Stage and Output Filter Components

- Assume 1.5 m Ω of output filter ESR.
-

$$R = (V_{IN} - V_{OUT}) \times \frac{V_{OUT}/V_{IN}}{F \times C \times 25 \text{ mV}}$$

$$= (5.0 - 1.6) \times \frac{1.6/5.0}{250 \text{ k} \times 0.01 \mu\text{F} \times 25 \text{ mV}}$$

$$= 17.4 \text{ k}\Omega$$

$$L/R_L = .01 \mu\text{F} \times 17.47 \text{ k}\Omega = 174 \mu\text{s}$$

Choose $R_L = 2.0 \text{ m}\Omega$

$$L = 2.0 \text{ m}\Omega \times 174 \mu\text{s} = 348 \text{ nH}$$

- n/a
-

$$P_{wstgZ} = R_L \times \text{CSA Gain} / 2.0$$

$$= 2.0 \text{ m}\Omega \times 3.15 / 2.0 = 3.1 \text{ m}\Omega$$

$$\text{ConverterZ} = \frac{P_{wstgZ} \times \text{ESR}}{P_{wstgZ} + \text{ESR}}$$

$$= \frac{3.1 \text{ m}\Omega \times 1.5 \text{ m}\Omega}{3.1 \text{ m}\Omega + 1.5 \text{ m}\Omega} \cong 1.0 \text{ m}\Omega$$

$$\Delta V_R = 1.0 \text{ m}\Omega \times 32 \text{ A} = 32 \text{ mV}$$

- n/a

Current Limit

-

$$V_{I(LIM)} = R_L \times I_{OUT(LIM)}$$

$$\times \text{CS to } I_{LIM} \text{ Gain}$$

$$= 2.0 \text{ m}\Omega \times 45 \text{ A} \times 6.25$$

$$= 562 \text{ mV}$$

Adaptive Positioning

7.

$$R_{V(FB)} = \text{NL Position}/V_{FB} \text{ Bias Current} \\ = 30 \text{ mV}/6.0 \mu\text{A} = 5.0 \text{ k}\Omega$$

8.

$$\Delta V_{DRP} = R_L \times I_{OUT} \\ \times \text{Current Sense to } V_{DRP} \text{ Gain} \\ = 2.0 \text{ m}\Omega \times 35 \text{ A} \times 3.0 \\ = 210 \text{ mV}$$

$$R_{V(DRP)} = \Delta V_{DRP} \times R_{V(FB)}/\Delta V_{OUT} \\ = 210 \text{ mV} \times 5.0 \text{ k}\Omega/40 \text{ mV} \\ = 26 \text{ k}\Omega$$

9.

$$I_{IN} = 1.52 \text{ V} \times \frac{41 \text{ A}}{0.85 \times 12 V_{IN}} = 6.1 \text{ A}$$

10.

$$\text{Duty Cycle} = \frac{1.52 \text{ V}}{0.85 \times 12 V_{IN}} = 0.15$$

11.

$$\text{Apparent Duty Cycle} = 0.15 \times 2.0 = 0.3$$

12.

$$\text{RMS ripple} = 6.1 \text{ A} \times 1.5 = 9.2 \text{ A}$$

OBSOLETE
 THIS DEVICE IS OBSOLETE
 PLEASE CONTACT YOUR ON SEMICONDUCTOR
 REPRESENTATIVE FOR INFORMATION

CS5302

PACKAGE DIMENSIONS

SO-28L
DW SUFFIX
CASE 751F-05
ISSUE F

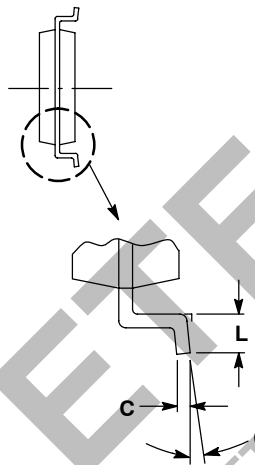
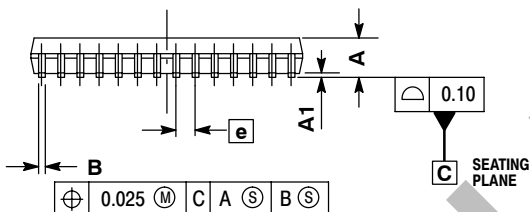
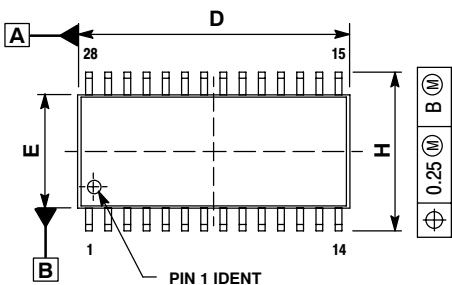

NOTES:

1. DIMENSIONS ARE IN MILLIMETERS.
2. INTERPRET DIMENSIONS AND TOLERANCES PER ASME Y14.5M, 1994.
3. DIMENSIONS D AND E DO NOT INCLUDE MOLD PROTRUSIONS.
4. MAXIMUM MOLD PROTRUSION 0.015 PER SIDE.
5. DIMENSION B DOES NOT INCLUDE DAMBAR PROTRUSION. ALLOWABLE DAMBAR PROTRUSION SHALL BE 0.13 TOTAL IN EXCESS OF B DIMENSION AT MAXIMUM MATERIAL CONDITION.

DIM	MILLIMETERS	
	MIN	MAX
A	2.35	2.65
A1	0.13	0.29
B	0.35	0.49
C	0.23	0.32
D	17.80	18.05
E	7.40	7.60
e	1.27 BSC	
H	10.05	10.55
L	0.41	0.90
θ	0°	8°

PACKAGE THERMAL DATA

Parameter		28 Lead SO Wide	Unit
R _{θJC}	Typical	15	°C/W
R _{θJA}	Typical	75	°C/W

V² is a trademark of Switch Power, Inc.

ON Semiconductor and are registered trademarks of Semiconductor Components Industries, LLC (SCILLC). SCILLC reserves the right to make changes without further notice to any products herein. SCILLC makes no warranty, representation or guarantee regarding the suitability of its products for any particular purpose, nor does SCILLC assume any liability arising out of the application or use of any product or circuit, and specifically disclaims any and all liability, including without limitation special, consequential or incidental damages. "Typical" parameters which may be provided in SCILLC data sheets and/or specifications can and do vary in different applications and actual performance may vary over time. All operating parameters, including "Typicals" must be validated for each customer application by customer's technical experts. SCILLC does not convey any license under its patent rights nor the rights of others. SCILLC products are not designed, intended, or authorized for use as components in systems intended for surgical implant into the body, or other applications intended to support or sustain life, or for any other application in which the failure of the SCILLC product could create a situation where personal injury or death may occur. Should Buyer purchase or use SCILLC products for any such unintended or unauthorized application, Buyer shall indemnify and hold SCILLC and its officers, employees, subsidiaries, affiliates, and distributors harmless against all claims, costs, damages, and expenses, and reasonable attorney fees arising out of, directly or indirectly, any claim of personal injury or death associated with such unintended or unauthorized use, even if such claim alleges that SCILLC was negligent regarding the design or manufacture of the part. SCILLC is an Equal Opportunity/Affirmative Action Employer. This literature is subject to all applicable copyright laws and is not for resale in any manner.

PUBLICATION ORDERING INFORMATION

LITERATURE FULFILLMENT:
Literature Distribution Center for ON Semiconductor
P.O. Box 5163, Denver, Colorado 80217 USA
Phone: 303-675-2175 or 800-344-3860 Toll Free USA/Canada
Fax: 303-675-2176 or 800-344-3867 Toll Free USA/Canada
Email: orderlit@onsemi.com

N. American Technical Support: 800-282-9855 Toll Free
USA/Canada
Europe, Middle East and Africa Technical Support:
Phone: 421 33 790 2910
Japan Customer Focus Center
Phone: 81-3-5773-3850

ON Semiconductor Website: www.onsemi.com
Order Literature: <http://www.onsemi.com/orderlit>

For additional information, please contact your local Sales Representative